

CAT. No.
5478-SS

NEMA 6-20P FLUSH MOUNT FLANGED INLET, GRAY, 2 POLE 3 WIRE GROUNDING, 20 AMPERE 250 VOLT

APPROVALS / CERT'S.

UL

ALL DIMENSIONS ARE IN MILLIMETERS

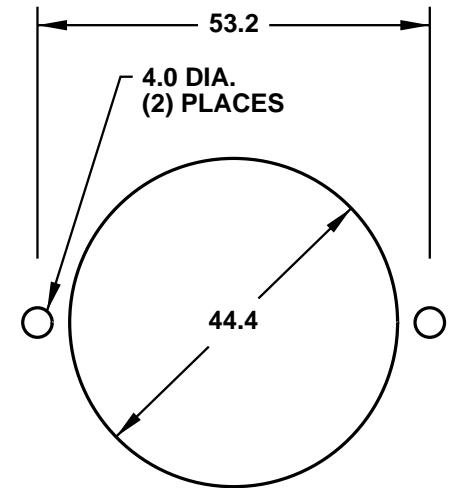
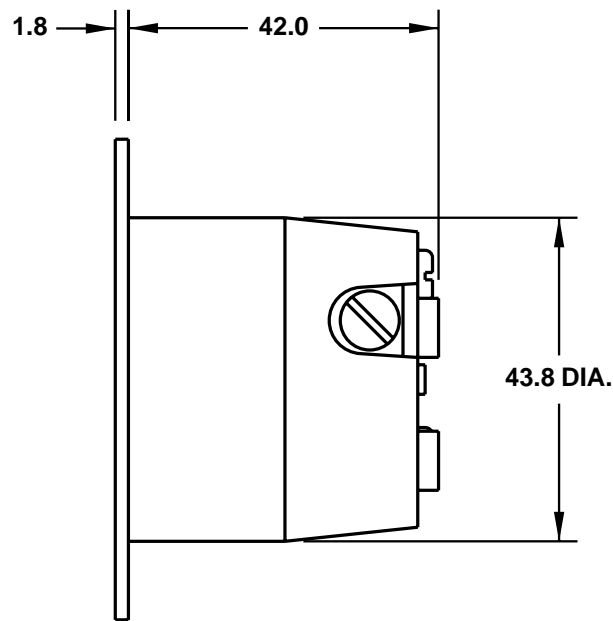
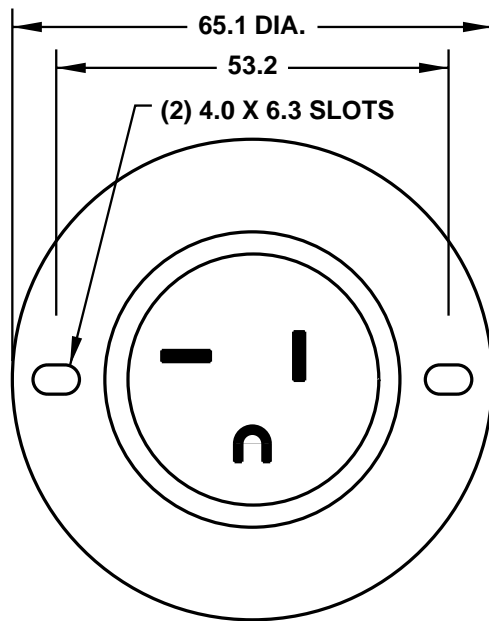

CUTOUT FOR
PANEL MOUNTING