

CAT. No.  
**74530**

**AUSTRALIAN PLUG (INSULATED LINE/NEUTRAL BLADES), ANGLE CORD GRIP, WHITE, 2 POLE 3 WIRE GROUNDING,  
15 AMPERE 250 VOLT, (AU 2-15P).  
STANDARD: AS/NZS 3112**

APPROVALS: DEPARTMENT OF FAIR TRADING

**ALL DIMENSIONS ARE IN MILLIMETERS**

MAXIMUM JACKET O.D. ACCEPTED BY EXTERNAL STRAIN RELIEF = 6 DIA (0.236")  
MAXIMUM JACKET O.D. ACCEPTED BY INTERNAL STRAIN RELIEF = 6 DIA (0.236")  
MAXIMUM CONDUCTOR SIZE ACCEPTED BY TERMINALS = 2.5 (14 AWG)

**CORDAGE PREPARATION**

<u>CONDUCTOR INSULATION COLOR</u>	<u>CONDUCTOR COLOR CODE</u>	<u>"LENGTH"</u>	<u>"STRIP"</u>
GREEN / YELLOW	GROUND	40	9
BLUE	NEUTRAL	40	9
BROWN	LINE	40	9

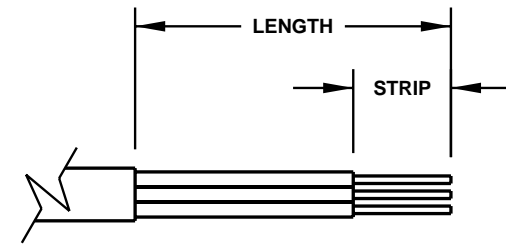

**CORDAGE PREPARATION**

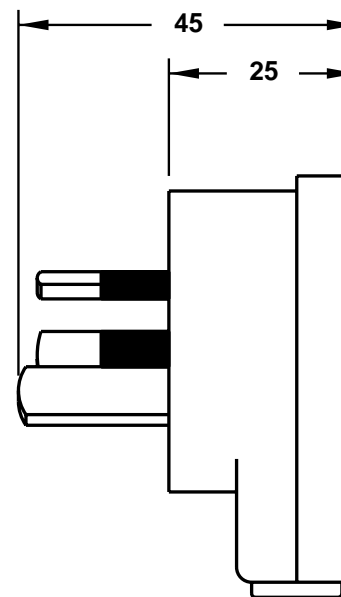
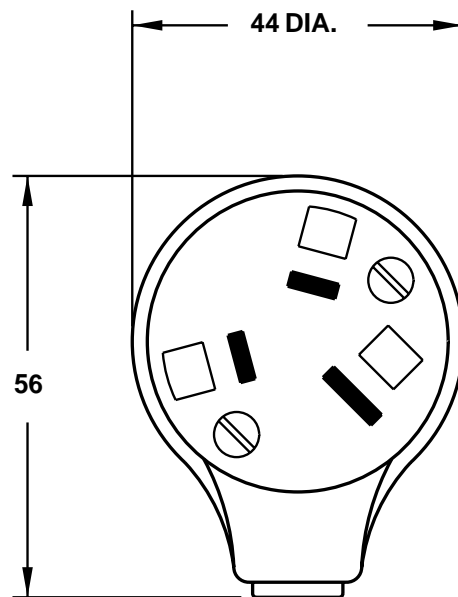

[www.InternationalConfig.com](http://www.InternationalConfig.com)  
[sales@internationalconfig.com](mailto:sales@internationalconfig.com)