

CAT. No.
888-2126

IEC 309 CEE 17 PLUG WITH COMPRESSION TYPE STRAIN RELIEF, BLUE, 20 AMPERE 250 VOLT (UL / CSA),
16 AMPERE 220 / 240VOLT (EUROPEAN), 50 / 60HZ , 2 POLE + EARTH
STANDARDS: IEC 309-1, IEC 304-2, BS 4343, DIN 49462/63, VDE 0623, CEE 17, EN 60309

APPROVALS / CERT'S.

CSA

UL

VDE

ALL DIMENSIONS ARE IN MILLIMETERS

MAXIMUM JACKET O.D. ACCEPTED BY EXTERNAL STRAIN RELIEF = 15 DIA (0.591")
MAXIMUM JACKET O.D. ACCEPTED BY INTERNAL STRAIN RELIEF = 15 DIA (0.591")
MAXIMUM CONDUCTOR SIZE ACCEPTED BY TERMINALS = 4.0 (12 AWG)

CORDAGE PREPARATION

CONDUCTOR INSULATION COLOR	CONDUCTOR COLOR CODE	"LENGTH"	"STRIP"
GREEN / YELLOW	GROUND	30	10
BLUE	NEUTRAL	35	10
BROWN	LINE	35	10

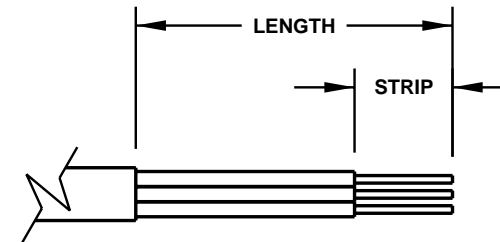

CORDAGE PREPARATION

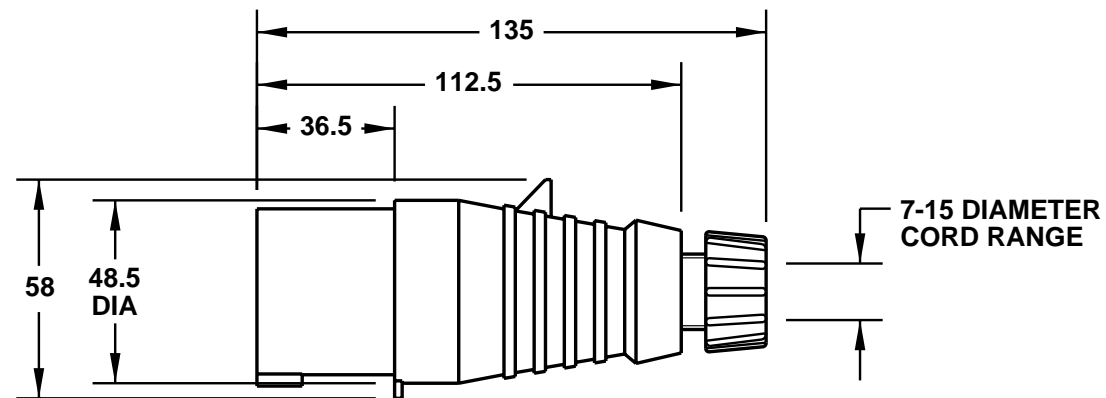
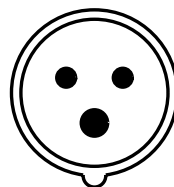

www.InternationalConfig.com
sales@internationalconfig.com